



***XBee® 802.15.4 Starter Kit  
Getting Started Guide***

©2012 Digi International Inc.  
All rights reserved.

Digi, Digi International, the Digi logo, the Digi web site, a Digi International Company, XBee, and Digi XBee are trademarks or registered trademarks of Digi International, Inc. in the United States and other countries worldwide. All other trademarks are the property of their respective owners.

All other trademarks mentioned in this document are the property of their respective owners. Information in this document is subject to change without notice and does not represent a commitment on the part of Digi International.

Digi provides this document “as is,” without warranty of any kind, either expressed or implied, including, but not limited to, the implied warranties of fitness or merchantability for a particular purpose. Digi may make improvements and/or changes in this manual or in the product(s) and/or the program(s) described in this manual at any time.

This document could include technical inaccuracies or typographical errors. Changes are periodically made to the information herein; these changes may be incorporated in new editions of the publication.

# Table of Contents

---

<b>Using this Guide</b> .....	<b>5</b>
Conventions used in this Guide.....	5
Contact Information.....	5
<b>Introduction</b> .....	<b>6</b>
Goals of the Kit.....	6
Requirements of the Kit.....	6
<b>Part 1: Set up your XBee 802.15.4 Starter Kit</b> .....	<b>7</b>
Identify Kit Components.....	7
Assemble your Starter Kit.....	8
<b>Part 2: Download and Install X-CTU Software</b> .....	<b>9</b>
Installing USB Drivers.....	9
Installing X-CTU Software.....	9
<b>Part 3: Test Communications Link and Establish a Network</b> .....	<b>10</b>
Perform a Range Test.....	10
<b>Part 4: Configure the Modules</b> .....	<b>15</b>
Set up a Point-to-Multipoint Network.....	15
<b>Part 5: Explore Advanced Configurations</b> .....	<b>16</b>
Configure Remote Modules.....	16
Change Firmware Version.....	18
Software Design Considerations.....	20
<b>Part 6: Managing the Network</b> .....	<b>21</b>
Digi Gateways.....	21
To the Cloud! Make the most of your data.....	22
To the Cloud! Take control of your device network.....	22

**Appendix A: Troubleshooting** .....23

    Resetting the XBee 802.15.4 Module..... 23

    Why are the modules no longer communicating with one another? ..... 23

# Using this Guide

---

## Conventions used in this Guide



This icon indicates a hint, or concept that is learned.



This icon indicates that a goal of the kit has been completed.



This icon indicates a warning of the potential for confusion or danger.

## Contact Information

For more information about your Digi products, or for customer service and technical support, contact Digi International.

To Contact Digi International	Use
Mail	Digi International World Headquarters 11001 Bren Road East Minnetonka, MN 55343
Phone 8:00 AM - 5:00 PM (U.S. Mountain Time)	1-866-765-9885 toll-free USA and Canada 1-801-765-9885 Worldwide
Online Support	<a href="http://www.digi.com/support/eservice/login.jsp">http://www.digi.com/support/eservice/login.jsp</a>
Email	<a href="mailto:support.wizards@digi.com">support.wizards@digi.com</a>

# Introduction

---

Thank you for purchasing an XBee® 802.15.4 Starter Kit. This kit is designed to make it easy to set up an XBee network, send data from one XBee to another, and adjust the XBee settings. Before you start working with the kit, let's cover some basics.

## Goals of the Kit

As you go through the steps in this kit, you will:



1. Set up your XBee 802.15.4 Starter Kit.
2. Download and install X-CTU configuration software.
3. Perform a range test.
4. Establish a network.
5. Configure the modules.

## Requirements of the Kit

### System Requirements

To install the software mentioned in this guide, you will need a PC running Microsoft Windows 2000, XP, Vista or Windows 7.

### Additional Documentation

For more information about the software, API operations, AT command modes, or the form factor please refer to the [XBee®/XBee-PRO® 802.15.4 Product Manual](#).

For more information on configuring and using the X-CTU utility, please refer to the [X-CTU Configuration & Test Utility Software User's Guide](#).

# Part 1: Set up your XBee 802.15.4 Starter Kit

---

## Identify Kit Components

Carefully unpack and verify the contents of your kit. Your kit should include the following:

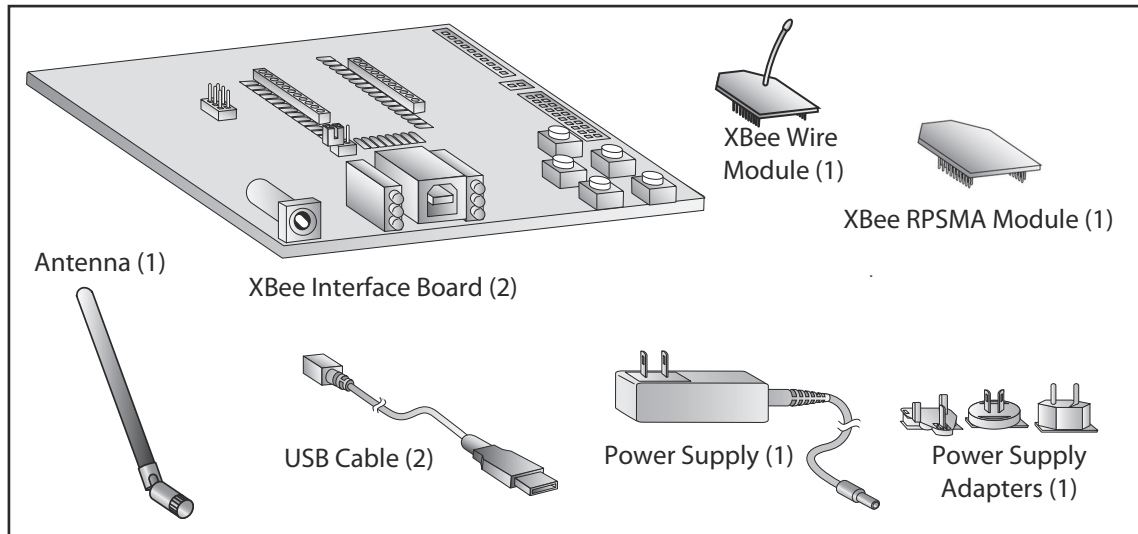

## **Assemble your Starter Kit**

To assemble your kit, perform the following steps:

1. Install the modules on the XBee Interface Boards (XBIB) by lining the pins up with the headers and pressing the module into place.
2. Attach the dipole antennas to the modules.
3. Connect the first XBIB to your computer using a USB cable. This first device will be designated as your base module.
4. Connect the remaining modules and interface boards, and set them aside for now.

You are now ready to run the X-CTU software and to begin configuring your XBee network.

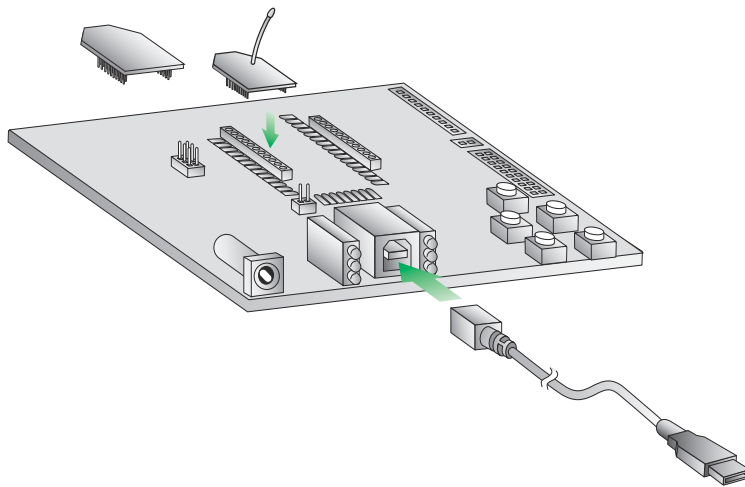

**You have just completed Goal #1 - setting up your  
XBee 802.15.4 Starter Kit.**



## Part 2: Download and Install X-CTU Software

---

For proper kit configuration and operation X-CTU software (version 5.15 or later) must be downloaded and installed. A copy of X-CTU software and USB drivers will need to be installed on each computer used in conjunction with this guide.

### Installing USB Drivers

The XBee USB interface board is a "plug-and-play" device that should be detected by the PC automatically. If you are using Windows 7 or Vista, the USB drivers should automatically install and a notification will appear in the lower right portion of your screen indicating success or failure.

If the USB drivers fail to install, please follow the USB driver installation instructions found here: <http://www.digi.com/support/kbase/kbaseresultdetl.jsp?id=3214>.

If you are using Windows 2000 or XP, download and install the driver as per the following directions.

To install the USB driver:

1. Download the driver setup file at:  
[http://ftp1.digi.com/support/driver/FTDI\\_Windows\\_Driver\\_Setup.exe](http://ftp1.digi.com/support/driver/FTDI_Windows_Driver_Setup.exe).
2. Double-click on the setup file. A window will pop up during installation and automatically close when the process is complete.

### Installing X-CTU Software

1. Download X-CTU at [www.digi.com/xctu](http://www.digi.com/xctu).
2. Browse to the folder to which you saved the above install file.
3. Double-click on the installer file and follow the X-CTU Setup Wizard.
4. When asked if you would like to check Digi's web site for firmware updates, click **Yes**.
5. After the firmware updates are complete, click **Close**. Updates may take a few minutes, please be patient.
6. Start X-CTU by double-clicking on the X-CTU icon on your desktop, or by selecting **Start > Programs > Digi > X-CTU**.

The X-CTU software is now ready to be used.



**You have just completed Goal #2 - downloading and installing the X-CTU configuration software.**

## Part 3: Test Communications Link and Establish a Network

---

### Perform a Range Test

Before running a range test, you will need to establish a connection with the X-CTU software:

1. Double-click the X-CTU shortcut on your desktop.
2. Under the PC Settings tab, select the serial COM port associated with the development boards you have just attached to your computer.

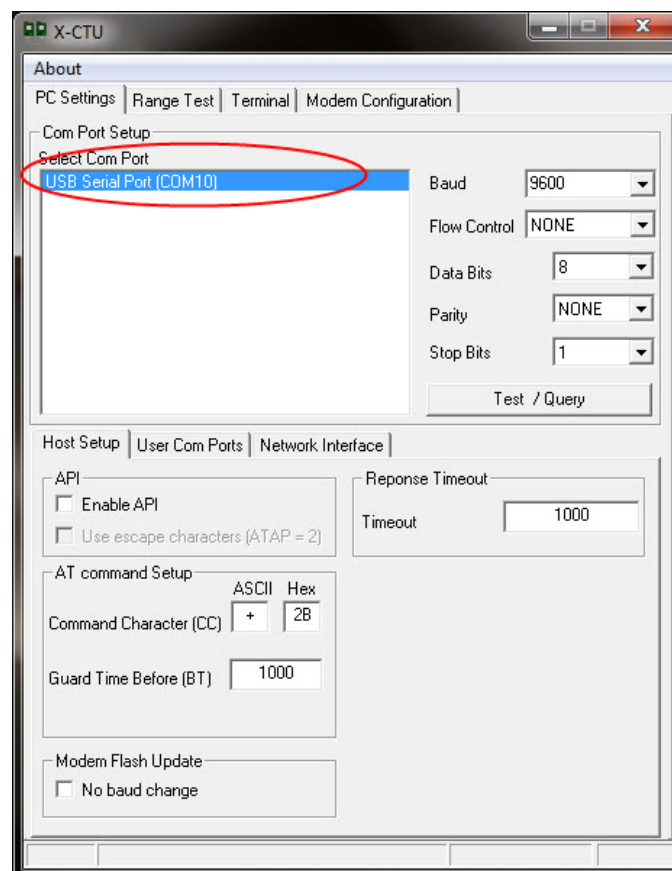

3. Verify that the baud rate and data settings match the internal settings of the devices:
  - Baud Rate: 9600
  - Flow Control: NONE
  - Data Bits: 8
  - Parity: NONE
  - Stop Bits: 1
4. Click the **Test/Query** button to verify communication with the module. A pop-up will be displayed showing status and some basic information.

5. On the **Modem Configuration** tab, click **Read**.
6. Apply power to the second module using a power supply in a fixed location. This will be designated as your remote module.

**Note:** You will need to have a jumper at P8 on the loopback header on the XBIB for the remote module.



Ensure that the P8 jumper is not bridging the two pins together on the base module. This could cause X-CTU to stall if the jumper is populated and requests are sent to the module.

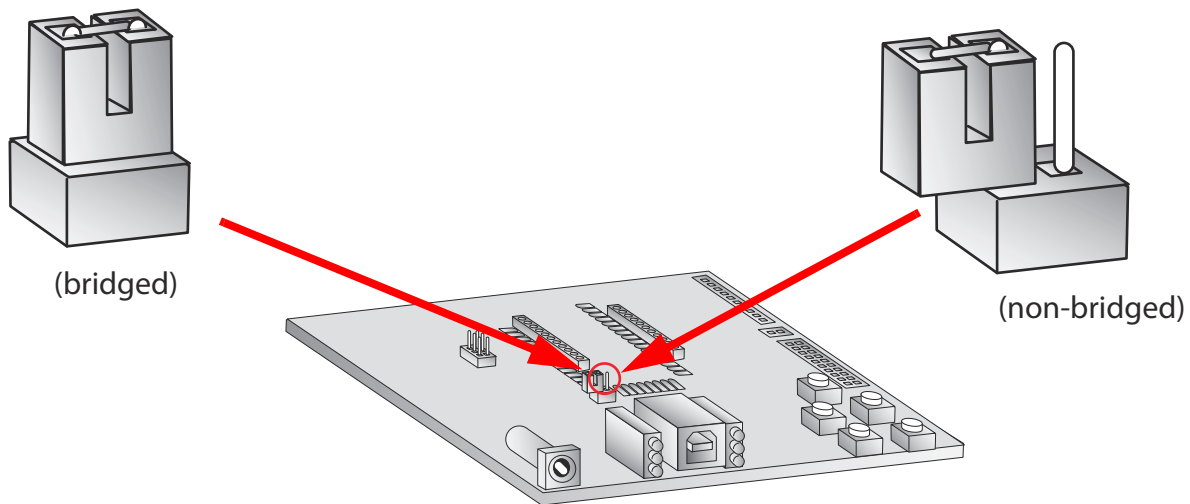

7. Select the **Range Test** tab.
8. (Optional) Check the **“RSSI” check box** to enable Received Signal Strength Indicator.

9. Click **Start** to begin the range test.

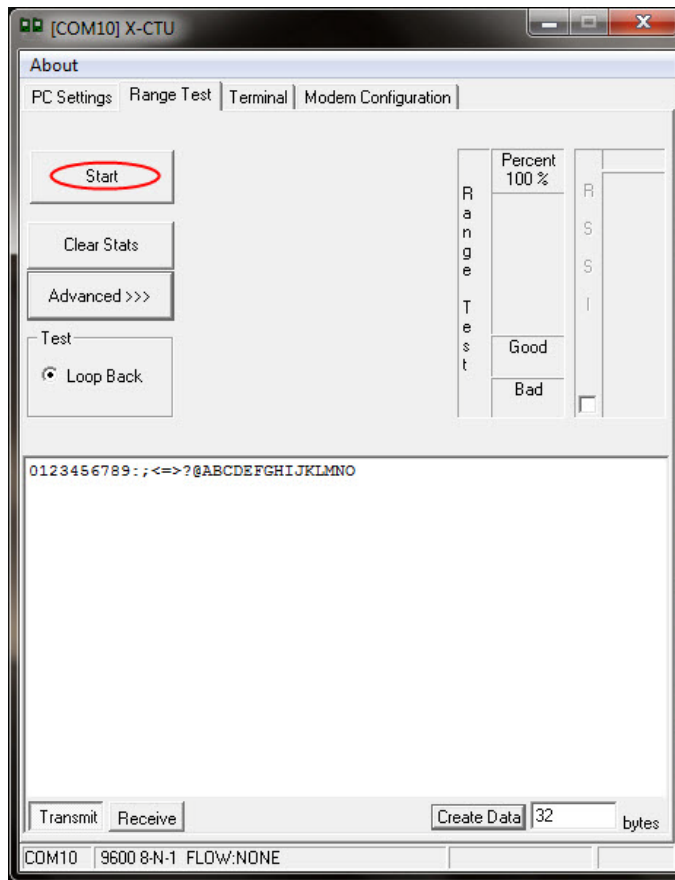

10. Monitor the link quality by reading the Percent section on the Range Test tab. This section displays the running percentage of good packets sent to the receiving module and looped back to the base.

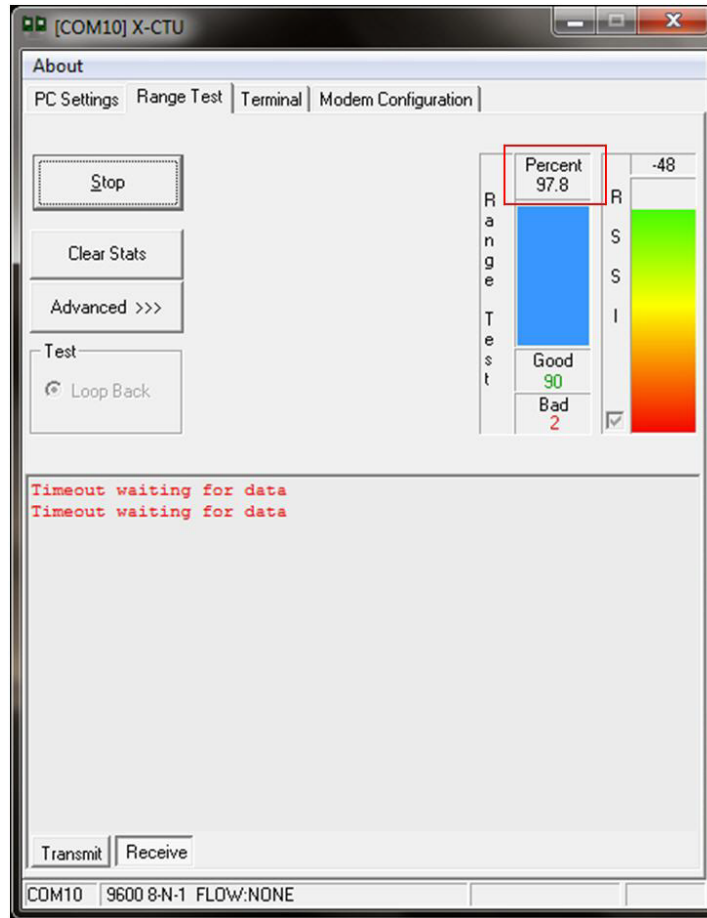

As your distance increases beyond the maximum range of the modules, you will start seeing greater packet loss.

11. Click **Stop** to end the range test.

The **Advanced** tab allows you the ability to increase the data receive time out. which defaults at one second.

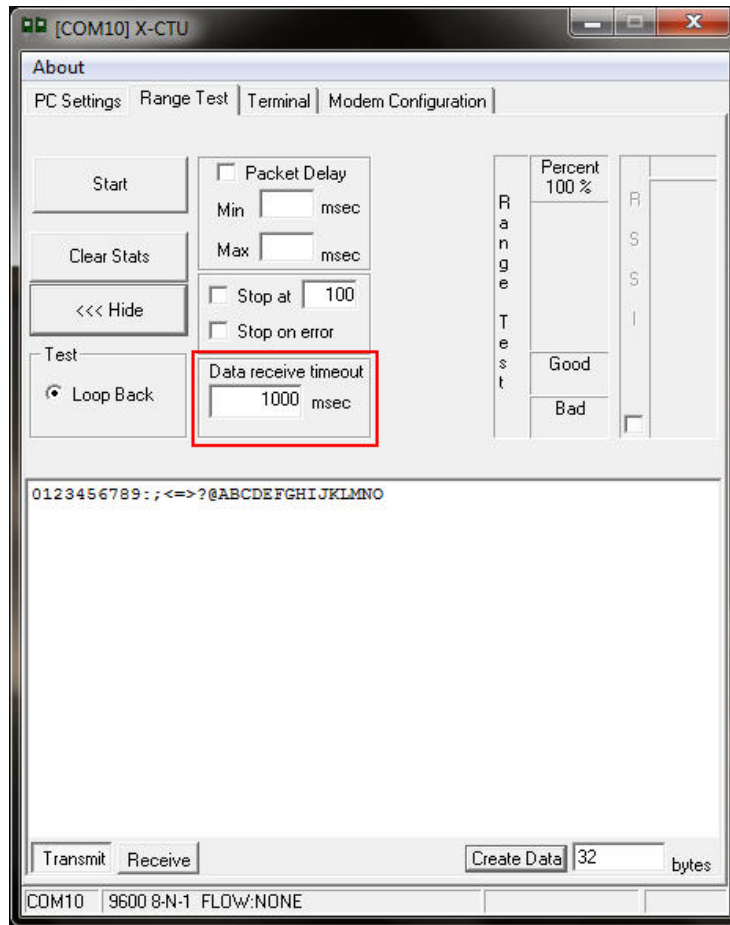

**You have just completed Goal #3 - performing a range test.**

## Part 4: Configure the Modules

### Set up a Point-to-Multipoint Network

To configure and set up your XBee network, perform the following steps:

1. In the **X-CTU Modem Configuration** tab, click **Read**.
2. Select any of the module parameters you want to change (e.g. Address, Encryption, etc.) and type in or select the desired value.
3. Then click **Write** to save the changes to non-volatile memory.
4. To restore the module back to defaults, click **Restore**.

Refer to the [product manual](#) for more information.

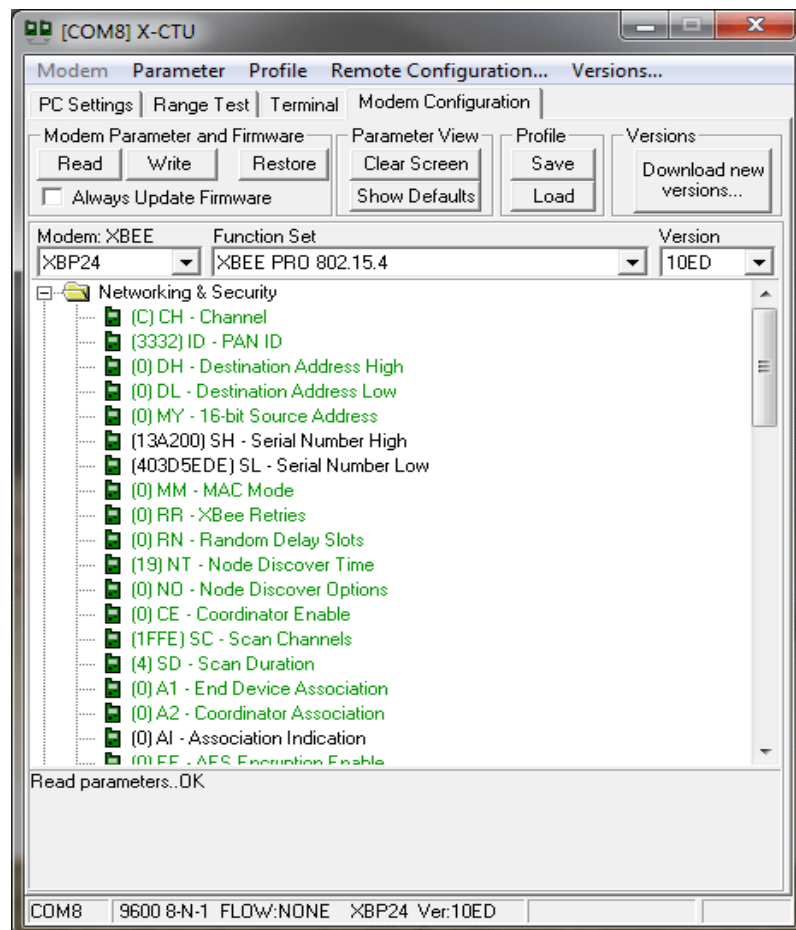

You have just completed Goal #4 - configuring the modules.

# Part 5: Explore Advanced Configurations

## Configure Remote Modules

The XBees can also be configured "over-the-air" using X-CTU. In order to use this feature, your base device must be configured for API mode.

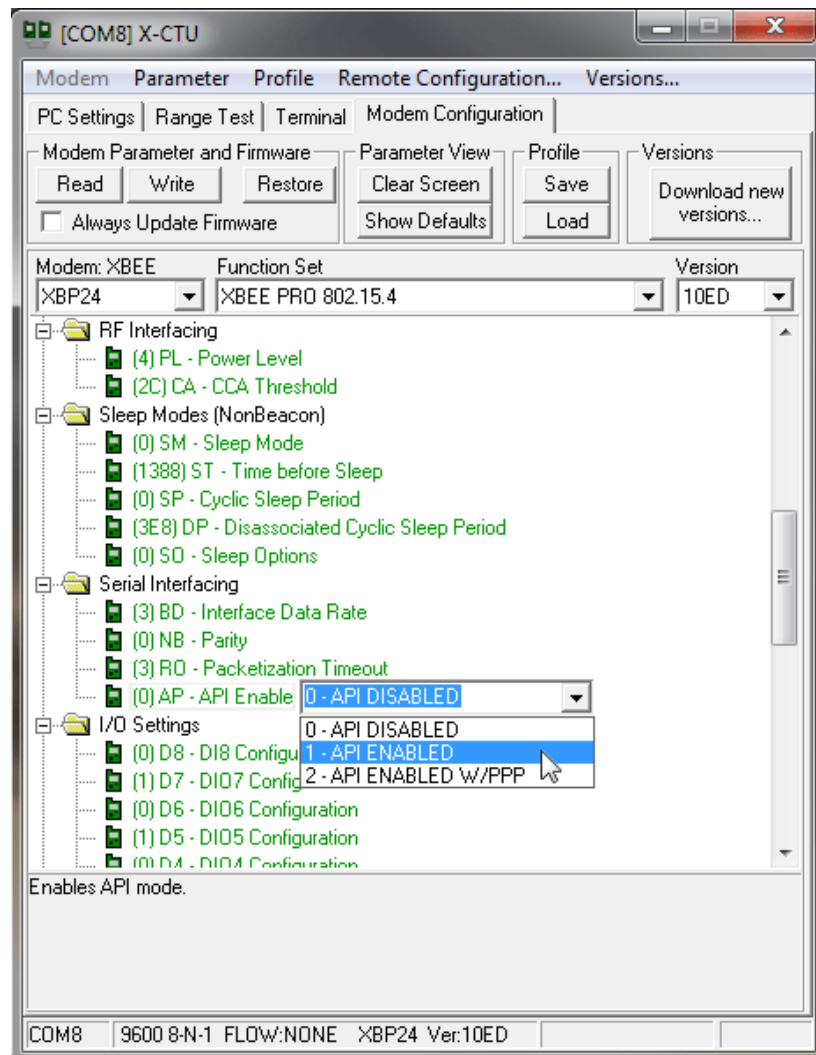

**Note:** To configure parameters on a remote module, set AP = 1 on your base module. For more information about the different AP settings, see the API section of the product manual.



To send “over-the-air” commands:

1. Go to the **Modem Configuration** tab and click the **Remote Configuration** option at the top of the window.
2. Click **Open Com Port** and **Discover** from the menu bar at the top of the **Network** window.  
A list of all of the nodes in the network will populate the screen.
3. Select a particular node from the list. You can interact with it as if it was connected to the PC directly.
4. Click **Read**, **Write**, or **Restore** parameters on the main X-CTU window and those changes will occur over the air on the remote module selected in the Network window.
5. Close the **Network** window when you have finished with remote configuration.

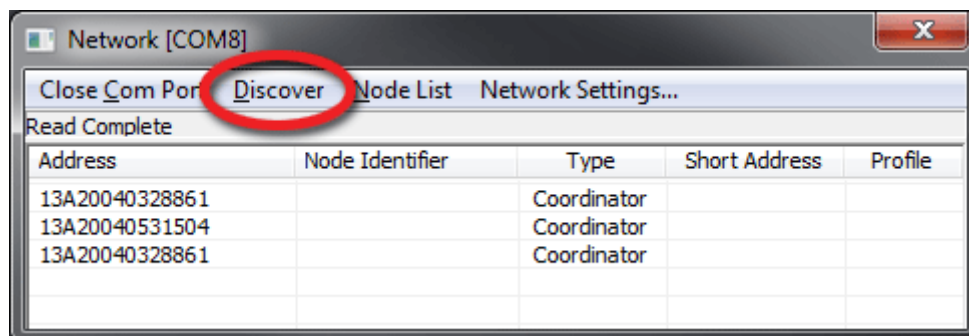
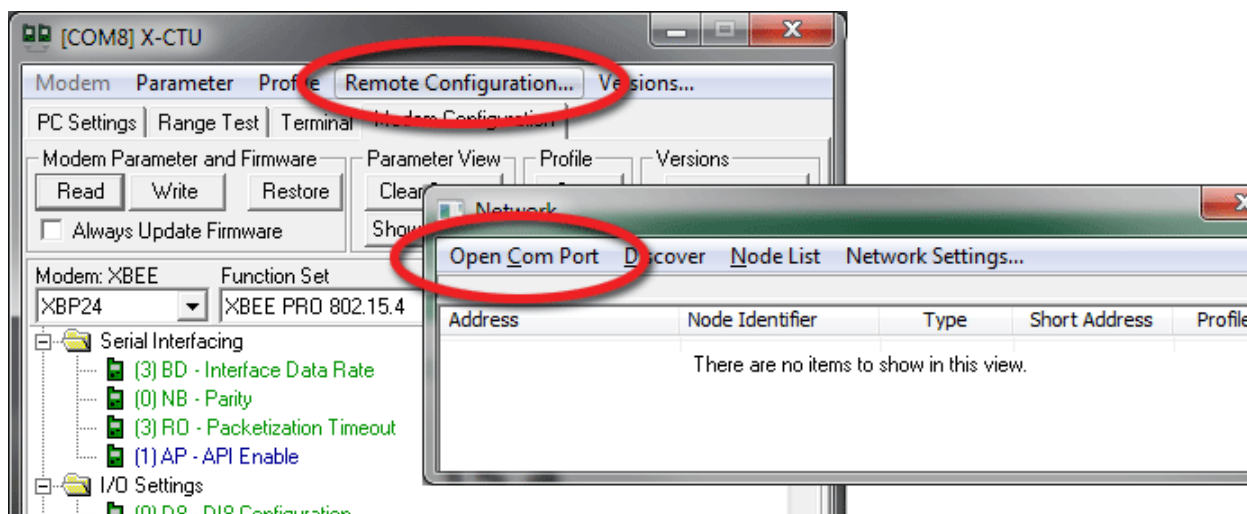

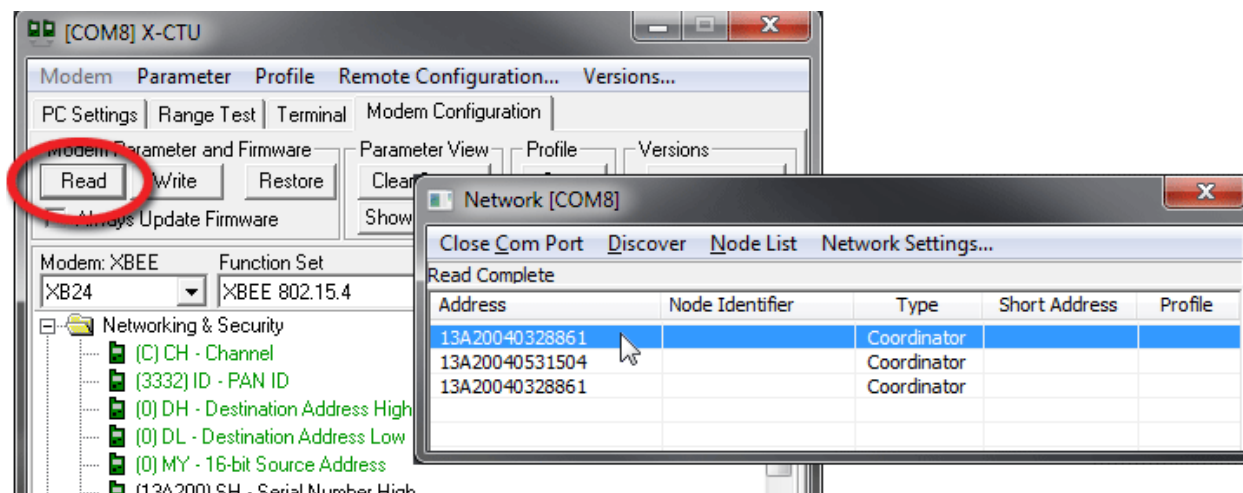

## Change Firmware Version

These modules can also be set up for mesh communications. In some cases, a mesh solution may be a better option. DigiMesh is better for networks needing routing capabilities. Also, DigiMesh provides the option for all the modules in the network to sleep synchronously. If you want to try mesh mode, you can simply load different firmware on your XBees.

These steps can also be used to update to the latest version of point-to-multipoint firmware.

1. Launch X-CTU and select the corresponding COM Port.
2. Set the PC settings back to default:
  - Baud Rate: 9600
  - Flow Control: HARDWARE
  - Data Bits: 8
  - Parity: NONE
  - Stop: Bits 1.
3. Click on the **Modem Configuration** tab.
4. Select the modem type. Choose XB24-DM or XBP24-DM to convert an XBee 802.15.4 module into a DigiMesh XBee or XBee-PRO 2.4 module. Leave the modem type as XBP24 to just update the point to multipoint firmware.
5. Choose the Function Set and firmware Version desired.
6. Click the **Show Defaults** button. This helps to avoid out of range errors since some parameters have different limits based on the firmware type.

7. Check the **Always update firmware** box.
8. Click **Write**.

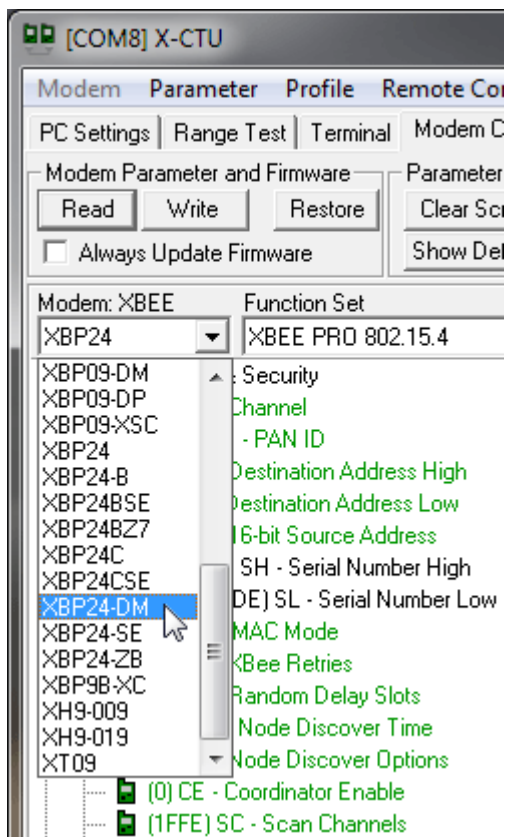

**Note:** When you select XBP24-DM, the function set that automatically loads is the standard DigiMesh one. The version that automatically loads is the newest firmware in X-CTU's database. You can click Download new version, and then download the latest firmware available from Digi's ftp site into XCTU's database on your PC.



**You have just completed Goal #5 - exploring advanced configurations.**

## Software Design Considerations

In this getting started guide we have been discussing the transmission of data between the modules in AT (transparent) mode. The benefit of using AT mode on the XBee network is that it is very simple to send and receive data. In this configuration, it acts as though you had connected the two radios with a wire: whatever data goes into one module comes out of the other transparently.

The other operating mode is API. This mode is a much more powerful way of transmitting data and remotely controlling the radio. If you performed the "over-the-air configuration", you have already performed some operations using API (Remote AT commands) through XCTU.

The easiest way to explain why using API is so useful is with a user scenario:

Let us say that you have installed three sensors to monitor your factory equipment. You would like to wirelessly gather the sensor data to a base radio and be able to remotely control a relay located at each sensor. If you were to use AT (transparent) mode, there would be no way to determine which sensor sent what data. The data from the three sensors would come out of the base radio's UART in a jumbled mess.

By simply changing the base radio to API mode, the data that is sent by the remote radios will come out of the UART in an API frame. Included in this frame is the source address as well as the sensor data, so it is very easy to keep track of each sensor. This process works similarly for sending data back to a specific radio. You can also send a Remote AT command to toggle a pin on one of the sensor radios, allowing you to remotely control the relay.

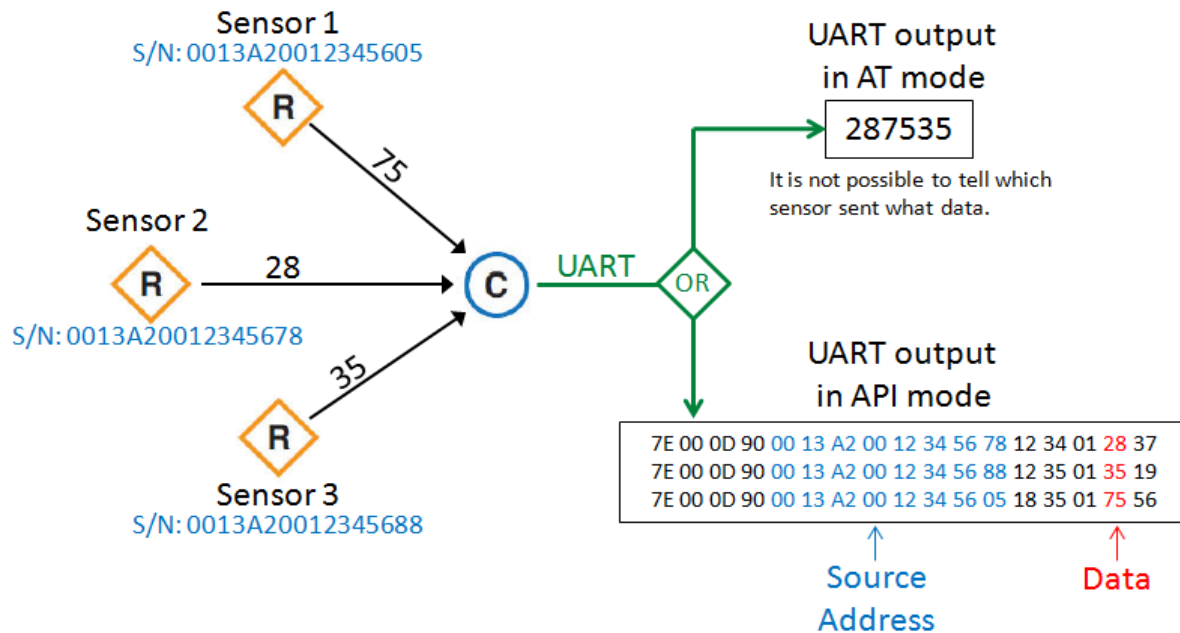

API mode is covered in detail in the product manual. We also have a useful [tool](#) available to aid in prototyping and testing API frames.

## Part 6: Managing the Network

### Digi Gateways

Now that you have an RF network running, it is important to know how to manage that network. X-CTU software and the various RF module features provide great tools for on-site XBee configuration, firmware upgrades, and network diagnostics. However, in many cases it is necessary to be able to perform these functions from a remote location via the Internet. Digi has solved this problem by creating RF-to-Internet gateways to allow remote access, monitoring and control of your RF network over the Internet.



In the diagram above, a Digi ConnectPort X2 gateway is used to connect an RF network (plus other peripherals) to the Internet via either the Ethernet port or a cellular WAN connection. Note that gateways are programmable and can also be used to run local applications, which can monitor/control the RF network, with or without Internet connectivity.

See <http://www.digi.com/products/wireless-routers-gateways/gateways/> for an overview of Digi's suite of gateway products. A simple ConnectPort X2 ZigBee to Ethernet gateway costs around \$100 and can quickly internet-enable your ZigBee network.

### ***To the Cloud! Make the most of your data.***

So you've created an RF network and connected it to the internet with a Digi gateway. Now what? The next step is to decide what you want to do with all of that valuable data. Ask yourself some fundamental questions. Does an application need to be developed, or is there an existing application that will be utilized? How should the data be presented? Who will be using this data? Is the audience internal, external or both? Whatever the answers to these questions, the iDigi Device Cloud can help you realize your vision and meet your needs for data capture.

The iDigi Device Cloud is a public cloud platform-as-a-service that allows any application, anywhere, to connect with anything, anywhere. iDigi takes care of the infrastructure, scalability and security, letting you focus on what you do best - developing awesome products and applications. Get up and running with iDigi for free and connect your device to explore what iDigi can do for you. Simply go to [www.idigi.com](http://www.idigi.com) and click on Get Started Now to set up a free demo account.

### ***To the Cloud! Take control of your device network.***

Picture this. You have a network of thousands of devices to manage, many of them remote. You need to update firmware, edit configurations, download software onto the various device types, dealing with IP addresses, firewalls, security and server reliability. Sounds like a mammoth task. The iDigi Manager Pro application, hosted on the iDigi Device Cloud, meets this challenge head on, allowing you to connect, control and monitor the vast array of devices in your network. Perfect for large-scale deployments, you can group devices and schedule operations, making device network management easy. Take a tour of iDigi Manager Pro at <http://www.idigi.com/tour/> and get started for free.

# Appendix A: Troubleshooting

---

## Resetting the XBee 802.15.4 Module

Each XBee USB Development Board has a reset button (located as shown below):

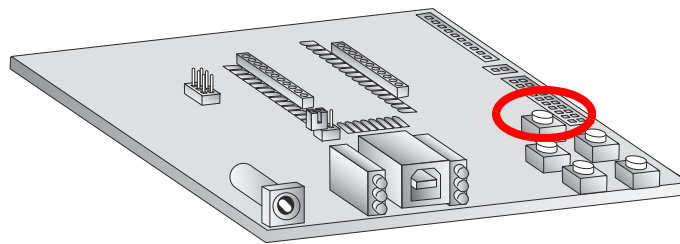

Pressing this button power cycles the module, but will not clear any changes written to the module. This is useful if you are having issues accessing the COM port. This will also reset any parameters that were changed but not written into memory.

**Note:** The remaining buttons are connected to various I/O lines and are not used in this kit. See the [product manual](#) for more details relating to this functionality.

## Why are the modules no longer communicating with one another?

Network settings that can cause loss of communication include Baud Rate (BD), Parity (NB), and Encryption Enable (EE) among others. Check to see if these parameters are set appropriately. If you are unsure if your settings are affecting your communication, you might want to try setting your modules back to their default settings. To do so, go to the Modem Configuration tab in X-CTU and click **Restore**.